

## Installation & User Manual For Cell Box Switch



GSM Cellular Gate opener and GSM alarm signalling device.

### **BFT Americas**

6100 Broken Sound Parkway N.W. Suite 14, Boca Raton, FL 33487



[www.bft-usa.com](http://www.bft-usa.com)

Toll Free: 877-995-8155

Office: 561-995-8155

Fax: 561-995-8160

# Contents

Overview of system	Pg 3
Site Survey	Pg 3
SIM card	Pg 3
Power	Pg 3
Inserting the SIM card	Pg 4
Connections on the GSM Controller	Pg 4
Output Connections example	Pg 4
Notification Feature	Pg 5
Powering Up	Pg 5
Programming	Pg 6
Programming as an Access Control Device	Pg 6
Programming as an Alarm Device	Pg 7
Complete List of Parameters	Pg 7
Controlling Relays as an Alarm Dialler	Pg 8
Control by SMS	Pg 9
Check if Gate/Door opened/closed	Pg 9
Using the Optional APP	Pg 9
Android APP Setup	Pg 9
iPhone APP setup	Pg 10
Troubleshooting Guide	Pg 11
Change History	Pg 12

# Overview of System

Please read this entire manual before attempting to install this system.

This system should only be installed by a professional automatic gate installer or access control specialist dealer.

It is recommended that the system be set up, configured, commissioned and tested on a workshop bench **before** taken to site for installation.

## Site Survey

Before installing this system, you need to be sure that there is good mobile GSM cell coverage in the area it is to be installed. It is recommended that you conduct a site survey, and check reception on the site for a GSM network. If reception is poor in the area, then this system is not recommended.

## SIM Card

You will need a SIM card in order to use this system. It should be a regular voice and SMS text SIM card. Do not use a data only SIM, as this is only for tablets and will not work in the unit.

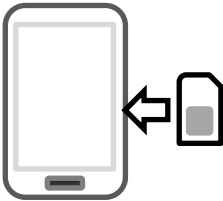

- 1) Ensure the SIM has calling credit, and can make and receive calls on a mobile cell phone.
- 2) Check that the SIM is not locked to a phone and can be used in other devices.
- 3) Check that the SIM does not have a PIN code request.
- 4) Disable voicemail service on the SIM.
- 4) You are now ready to begin programming.

## Power

**TIP: Most technical calls received are due to installers using CAT5 or alarm cable to power the unit. Neither are rated to carry enough power (2 amp peak). Please use following cable...**

Up to 2 metres (6 feet) – Use minimum 0.5mm<sup>2</sup> (18 gauge)  
Up to 4 metres (12 feet) – Use minimum 0.75mm<sup>2</sup> (16 gauge)  
Up to 8 metres (24 feet) – Use minimum 1.0mm<sup>2</sup> (14 gauge)



### **WARNING**

Warranty VOID if power cable requirements are not followed!

Using insufficient power cable thickness will cause excessive stress on electronic components, and therefore void the manufacturer's warranty.

To avoid such problems it is recommended (and is good practice) to locate the power supply as close to the transmitter as possible. This avoids power cable noise and interference and enhances the lifetime of the product.

# Inserting the SIM card

Note: This unit is a dual 2G/3G quad band system, operating on standard 2G network frequencies of 850/900/1800/1900MHz and 3G frequencies of 900/2100MHz.



Do not use a SIM card for a tablet, as these only support data, and do not support voice and SMS. You simply require a cellular phone type SIM card.

- 1) Ensure the power is OFF
- 2) Slide the SIM card holder in the open direction, and carefully open the door. Do NOT force it.

## Connections on the GSM Controller

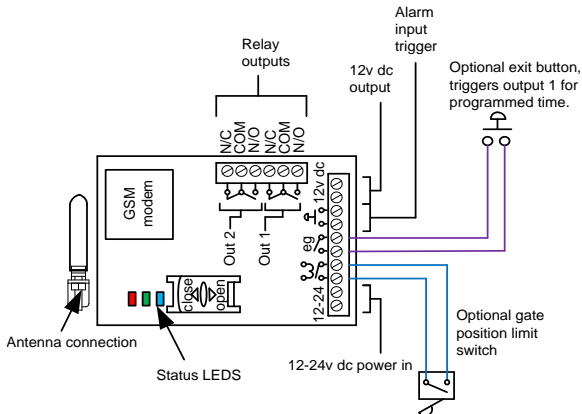

## Output Connections Example

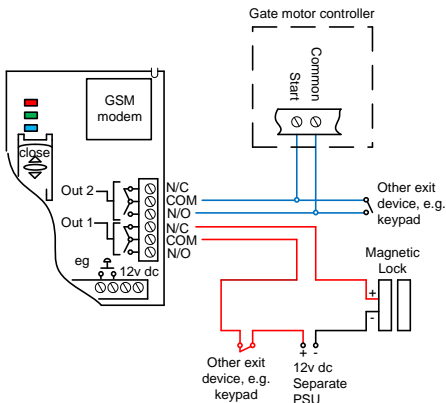

This example shows relay 2 connected to a gate motor controller for vehicle gates, and output 1 connected to a magnetic lock for a door or pedestrian gate.

## Alternative Keypad Wiring for Notification Feature

The Cell Box Switch has an additional feature which sends an SMS to a master user when the GSM unit triggers it's outputs. So if the user wants to know when an external device such as a keypad is triggered, then wire a keypad output to egress input of the GSM as shown...

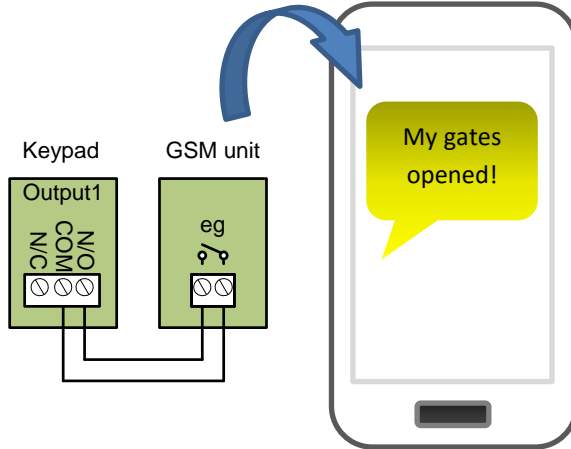

When the egress is triggered, the GSM unit's output 1 will be triggered and if the 78 feature is programmed, the unit will send an SMS.

## Powering Up 12v-24v DC Only

Perform a final check of wiring, making sure that the power supply is no more than the maximum 24v DC and ensure the antenna is connected before switching on the power. Once the power is switched on, the power LED should illuminate.

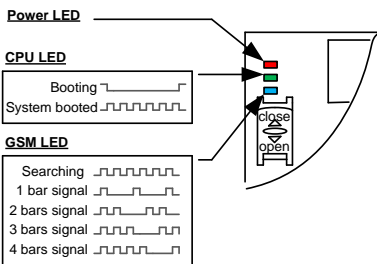

### **TIPS:**

#### **My GSM LED is still searching...**

- Check the SIM card is registered and can make a call in a phone.
- Check the SIM card is seated correctly. Power off, clean the contacts on the SIM and the GSM unit, and reinsert the SIM.
- Check power cable distance and thickness.
- Increase antenna height.
- Change network.
- Move antenna away from metal objects or overhanging shrubs.
- Fit a high gain antenna.

# Programming

**TIP:** The GSM unit programming is by sending SMS text messages to the unit from a phone.

## Check Reception

Send the SMS **\*20#** as shown, to the SIM card number of the intercom. The unit should reply with a reception level between 1 and 31.

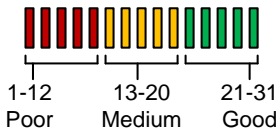

Note: Reception levels below 14 can give problems with the relay operation

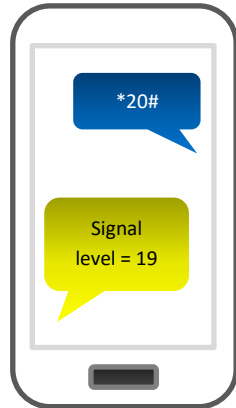

**TIP:** If reception levels are low, take action now! Either increase the height of the antenna to improve reception or request a higher gain antenna from your distributor or change to another network which may have better coverage.

## Programming as a Gate / Door Access control Device

The unit is able to store up to 100 telephone numbers which can call the intercom and trigger the relay automatically with caller ID. Programming text messages must start with a pass code string, followed by a command, followed by data, and each command is separated in the SMS by #. Enter the phone numbers you require to have access in SMS strings as follows...

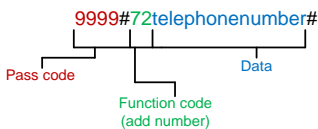

Tip: Up to 4 telephone numbers can be sent together in the same SMS message. Simply separate each with 72 as shown...

9999#72telephonenumber#72telephonenumber#  
72telephonenumber#72telephonenumber#

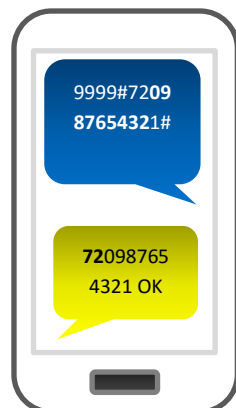

## Programming as an Alarm Dialling Device

This advanced GSM unit is also able to be used as a GSM alarm device. If the input terminals are triggered with a closing connection, the device will call up to 4 phone numbers in sequence.

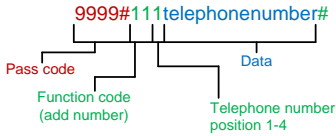

Tip: Up to 4 telephone numbers can be dialled in the event of an alarm. Simply change the number position digit as shown...

`9999#1111telephonenumber#112telephonenumber#113telephonenumber#114telephonenumber#`

## GSM unit complete list of parameters

The table below show the complete list of features in the cellular part of the intercom.

**Programming messages below must begin with 9999# (assuming 9999 is still the programming passcode)...**

### Changing pass codes

01????#	Change programming password	9999
02????#	Change access control password (SMS control of relays, or non-stored numbers can call intercom & enter code to activate output 1).	1234
03????#	Change monitoring mode password (user can call the intercom, enter this pass code to listen in and speak)	5555

### Dial out numbers

1XY????#	Store dialling out numbers. (X = button number 1-9 & 0 for button 10) (Y = number dialled 1-4) (???? = phone number)	N/A
1XY*#	Delete a dial out number. (X = button number) (Y = number position 1-4)	N/A

### Timings

50?#	Relay 1 time. ? = seconds, 1-9999	1 sec
51?#	Relay 2 time. ? = seconds, 1-9999.	1 sec
45??#	Calling time for first number, adjust this to avoid voicemail picking up a call (10-99 secs)	20 secs
46??#	Calling time for second number, adjust this to avoid voicemail picking up a call (10-99 secs)	20 secs
47??#	Calling time for third number, adjust this to avoid voicemail picking up a call (10-99 secs)	20 secs

### **Scheduled service calls**

77number#	Store a service number to receive a scheduled call or SMS from the unit. Useful for SIM cards which are not often used to prevent switch off by the network provider.	N/A
57??#	Set the time schedule for the intercom to make a scheduled call or SMS to the service number. 00-60 day time schedule. 00 = no call or SMS.	00
58?#	Choose between making a scheduled call or scheduled SMS. 1 = SMS. 2 = call.	1
77*#	Delete the stored service number	N/A

### **Notification Number**

78number#	Store a master user, who will receive a SMS notification from the intercom each time any of the output relays are triggered.	N/A
79text#	Where "text" is the content of the message to be sent. E.g. "Gates Opened, or Door Opened". This will be sent on closing of any output relay.	N/A
80?#	When ? = 1, this function is disabled. Set to 2 to enable.	N/A

### **Caller ID features**

72number#	Store caller ID number. Max 14 digits. Only last 6 digits compared.	N/A
73number#	Delete caller ID number.	N/A
73*#	Delete all caller ID numbers	N/A

### **Service & diagnostic messages (no passcode required for these!)**

*20#	Check reception level 1-31 (no passcode needed)	N/A
*21#	Check stored numbers. O = dial out number. I = dial in number. E = end of message. (no passcode needed)	N/A
*22#	Check input status and relay status. (No passcode needed)	N/A
*23#	Call log of last 25 Caller ID numbers	N/A

### **Restore Defaults**

999#	Send with passcode string to clear all programming.	N/A
------	---	-----

## Controlling Relays when used as Alarm Dialler

If the alarm input is used to trigger the unit and call a phone, the user can answer the call and control the relays with DTMF touch tones on their phone as follows..

#### **Relay 1**

Press **1** to momentary trigger  
 Press **2** to Latch or hold open  
 Press **3** to unlatch or close.

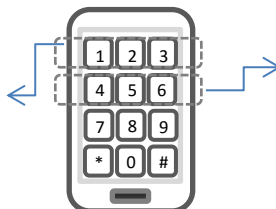

#### **Relay 2**

Press **4** to momentary trigger  
 Press **5** to Latch or hold open  
 Press **6** to unlatch or close



## Control by SMS

This device allows the user to send SMS commands to control the relays as follows...

1234#1# - Relay 1 momentary trigger.

1234#2# - Relay 1 latch ON or hold ON.

1234#3# - Relay 1 unlatch or switch OFF.

1234#4# - Relay 2 momentary trigger.

1234#5# - Relay 2 latch ON or hold ON.

1234#6# - Relay 2 unlatch or switch OFF.

### Check if door or gate is open or closed



Send the SMS as shown, and the unit will reply showing the status of the input limit switch (if used), and the relay..

This example shows that the input sensor is in OPEN state. Relay 1 is OFF and Relay 2 is latched ON.

**TIP:** If there is not a physical limit switch fitted to the door or gate, then the status input will always show OPEN.

### Using the Optional App

Android and iPhone users can download an optional app called **Cell Box PLUS**. This app performs 3 main functions..

- 1) Speed dials your Cell Box Switch when the trigger button is pressed.
- 2) Sends pre-configured SMS messages to latch and unlatch relays.
- 3) Allow the user to check status like reception level and status of the outputs and inputs.

Once the app is installed, you will need to decide on and enter names for each of the buttons.

Note: There are 2 screens, one for each relay.

### Android App Setup

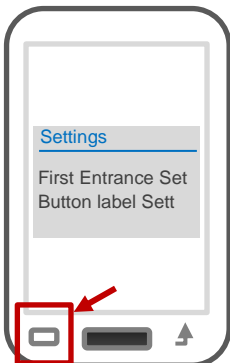

On Android, press the settings button on the device (bottom left) and the settings options will appear.

You can use these options to name each entrance, gate or output, and then name the button functions. For example, if relay 1 is connected to automatic gates, you might choose to name the main momentary trigger button as "VEHICLE OPEN", or "MAIN GATE". For the latching buttons, you may decide to name them for example "Hold Gate", or "Latch Gate".

The phone number of the intercom and the SMS message strings also need entered into the app settings.

Once the buttons and screen labels are entered and saved, then the app should be ready to use.

Main Trigger button  
Use this to speed dial the Switch and momentary trigger relay 1.

Latch Relay Button  
Sends a pre-configured SMS to latch on the relay. Can be used to hold open gates or door.

More Features  
Use this to check gate signal strength, gate position, stored numbers and other advanced

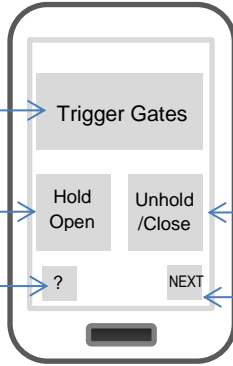

Un-Latch Relay Button  
Sends a pre-configured SMS to unlatch the relay if it has previously been latched. Can be used to allow gates to close

NEXT  
Press to display relay 2 screen and controls.

## iPhone App Setup

On iPhone the user is also required to enter button labels, the intercom phone number and the default message strings to perform the latch and unlatch functions. To do this, press the label button shown below.

Trigger Relay Button

Latch Relay Button

More Features  
Use this to check gate signal strength, gate position, stored numbers and other advanced features. .

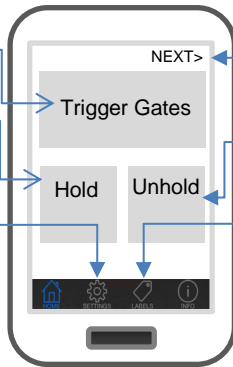

Press to go to Relay 2 controls.

Un-Latch Relay Button

Press to setup label and button names

# Troubleshooting guide

## **Q. The unit will not power up. No LEDs on.**

A. Check alarm or CAT5 cable has not been used to power the device. If it has, the warranty will be void. Please remove and replace as per instructions.

## **Q. The unit powers up but is not showing network reception or will not respond to SMS.**

A. This means the unit is not able to detect the network for some reason.

-Check the SIM card is activated and has calling credit.

-Power off the unit, remove the SIM and check it in a mobile phone to verify it can make a call.

-Check the SIM does not ask for a PIN code when put in a phone. If it does, then disable the PIN code request.

-Check the SIM is a standard voice SIM and not a data only SIM for a tablet.

-Check the reception is strong. Poor reception is not sufficient.

- Check alarm or CAT5 cable has not been used to power the device. If it has, the warranty will be void. Please remove and replace as per instructions.

-Power off, remove the SIM, use fine sand paper or a sharp object to lightly clean the SIM pads and contacts on the GSM unit. Gently bend the contacts upwards so that they make better contact with the SIM and try again.

## **Q. The caller ID part does not work.**

A. Be sure to program the caller ID part under 72 feature. If your number is a private or number withheld, then it will not work.

-Even if you have already programmed a number to receive a call from the device, if you also want that number to have caller ID access, it must be programmed under the 72 feature also.

-Ensure the number is entered as you would normally dial it from another phone.

## **Q. The keys do not work when the device calls a phone.**

A. Check if you can hear the relay clicking at the gate when the keys are pressed during a call. If it can be heard, then the system is working, check wiring between the relay and the lock or gate panel. If the relays do not make a clicking sound, then check this feature on a different mobile cell phone or landline. If it works on a different phone, check the settings on the phone in question under DTMF tones.

Failure of DTMF tones to operate correctly is also a symptom of low reception. Check steps above on improving reception. Try pressing the buttons longer when attempting to activate the gates or door.

Also check that the relays are not already latched with the \*22# command. If they are latched, they need unlatched before the trigger keys will work.

## **Q. The system was operating the gates fine, but now it will not trigger the gates.**

Most of the time, this is cause by the user accidentally latching the relay. This latches the output relay permanently on. Send the intercom the following SMS \*22#. The device should reply with a message detailing the relay status.. If it has been latched, then the message will state "the relay is ON". In this case refer to the user guide to read how to unlatch it again.

## **Q. The unit no longer calls out to phones but I can make a call to it from my phone.**

A – Check there is balance on the SIM card.

A – Switch off the power, remove the SIM, put it into a phone, and check that a call can be made from a phone. This will verify if the SIM is still working and in service.

# Change History

Key:

H = Hardware PCB version    S = Software version

Reason for change		
H	S	
1	1	First version.
2	1	Power chip upgraded to work on 24v dc (24v adaptor in kits).
2	2	Software feature added for call log to show last 25 caller ID calls.
3	2	Main capacitor, regulator & diode upgraded for 24v dc.

